

Trinity

Model # TR.194.04

1-Compartment Industrial Sink

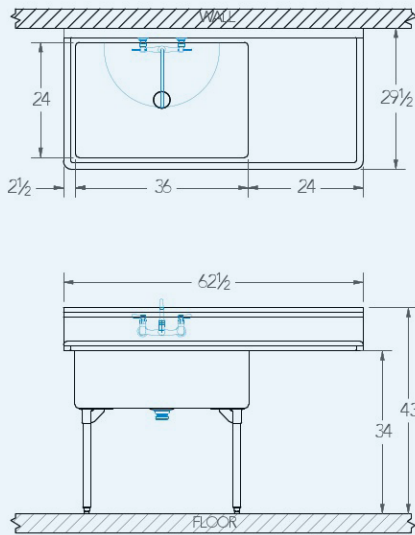

Bowl (Lg x Wd x Dp)

36" x 24" x 12"

Drainboard

Left: -"

Right: 24"

Overall (Lg x Wd x Ht)

62 1/2" x 29 1/2" x 43"

Material

14 gauge, stainless steel

Faucet Holes

1-1/8" Dia 8" Centers

Drain

3-1/2" Dia Opening

Included:



Matched Faucet



Basket Drain(s)



Install Kit

Additional Features

- 14 gauge stainless steel
- NSF approved construction
- R 3/4" coved compartments
- 12" deep compartments
- Stainless steel legs & feet
- Bi-directional gusseted leg sockets
- 9" tile-edge backsplash
- 1-1/2" sanitary rolled-rim
- D 3-1/2" recessed drain opening
- Specification grade hardware included
- 10-year warranty
- Made in Texas