

# Sabine

Model # SA.288.80

2-Compartment Food Service Sink

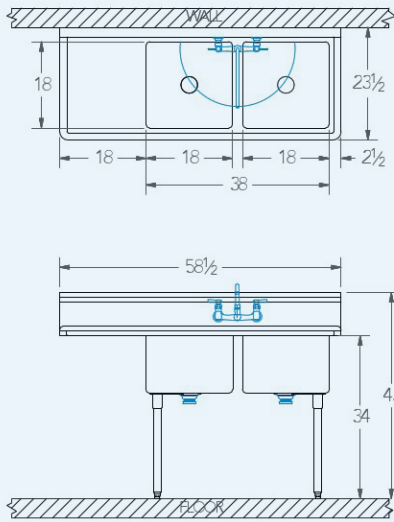

### Bowl (Lg x Wd x Dp)

18" x 18" x 12"

### Drainboard

Left: 18"

Right: 0"

### Overall (Lg x Wd x Ht)

58 1/2" x 23 1/2" x 43"

### Material

16 gauge, stainless steel

### Faucet Holes

1-1/8" Dia 8" Centers

### Drain

3-1/2" Dia Opening

### Included:



Matched Faucet



Basket Drain(s)



Install Kit

### Additional Features

- NSF approved construction
- R 3/4" coved compartments
- 12" deep compartments
- Stainless steel legs
- Stainless steel feet
- 9" tile-edge backsplash
- 1-1/2" sanitary rolled-rim
- D 3-1/2" recessed drain opening
- Specification grade hardware included
- 5-year warranty
- Made in Texas